

Q-Zone Hoop Frame

Fabric Installation Instructions

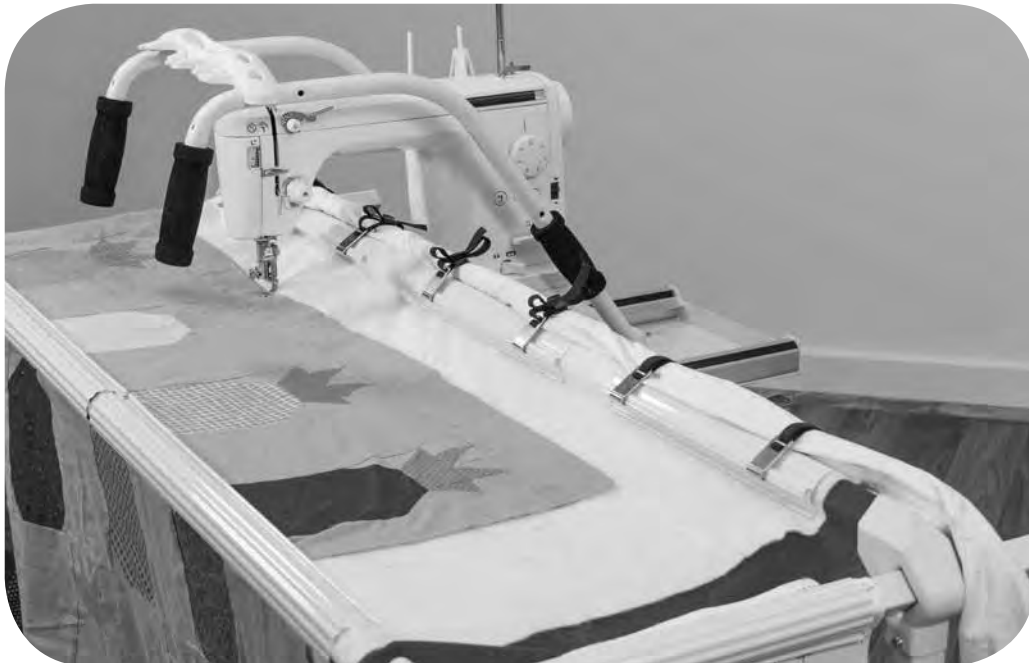

Copyright July 11, 2018
Grace Company
(Reproduction Prohibited)
Version 1.0

Table of Contents | Q-Zone Hoop Frame

Installing Fabric Using Cloth Leaders

Step 1 – Quilt Preparation	2
Step 2 – Fabric to Frame	6
Step 3 – Moving Fabric to a New Quilting Zone	12

Installing Fabric Without Using Cloth Leaders

Step 1 – Quilt Preparation	15
Step 2 – Fabric to Frame	18
Step 3 – Moving Fabric to a New Quilting Zone	24

Using Bungee Clamps for Smaller Projects

Step 1 – Bungee Clamp Setup for Smaller Projects	27
--	----

Installing Fabric Using Cloth Leaders

Creating a quilt using Cloth Leaders allows you to use a smaller backing for your quilt. The following are instructions on how to set up your project using Cloth Leaders.

With Cloth Leaders | Q-Zone Hoop Frame

Step 1 – Quilt Preparation

Parts Needed:



Backing Material

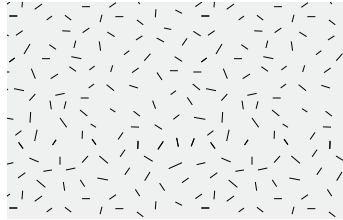

Batting Material

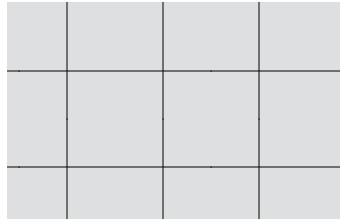

Quilt Top Material



Back Rail Cloth Leader



Front Rail Cloth Leader

Tools Needed:

Pins or Masking Tape

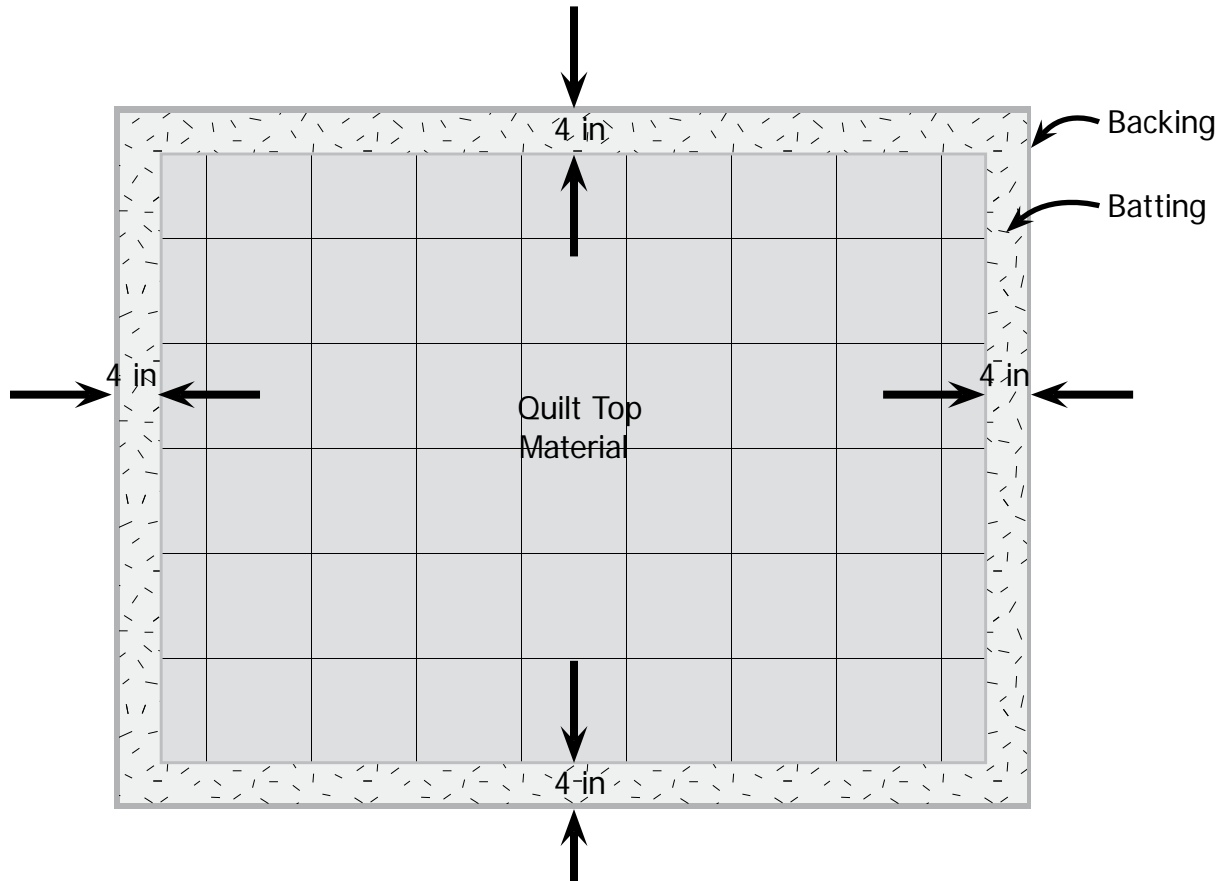

1-1 Cut your *Backing* and *Batting* **8 in** wider than your *Quilt Top Material* or **4 in** on each side.

With Cloth Leaders | Q-Zone Hoop Frame

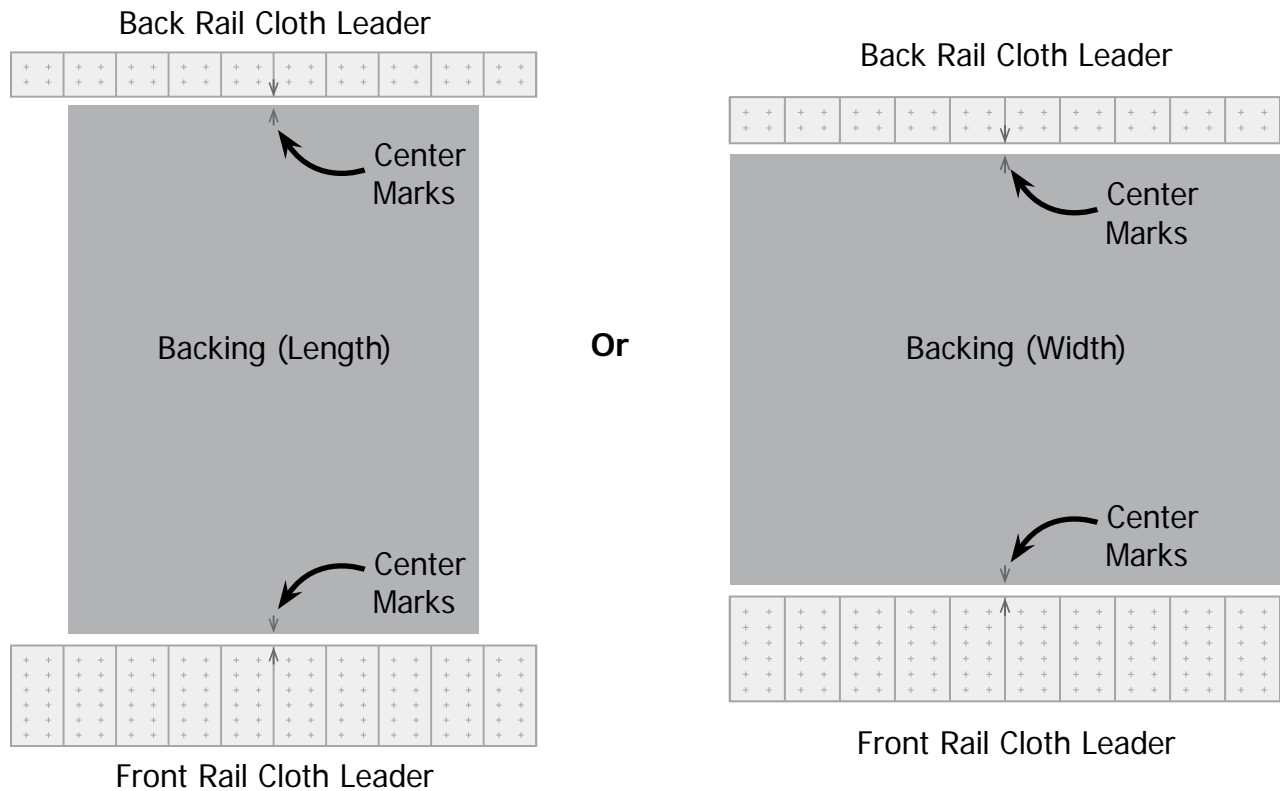

1-2 Find the center on your *Back Rail Cloth Leader* and *Front Rail Cloth Leader* and mark it. Find the center on your *Backing* on both the front and back rail edges and mark it. Lay the *Backing* with the visible side down on a clean surface.

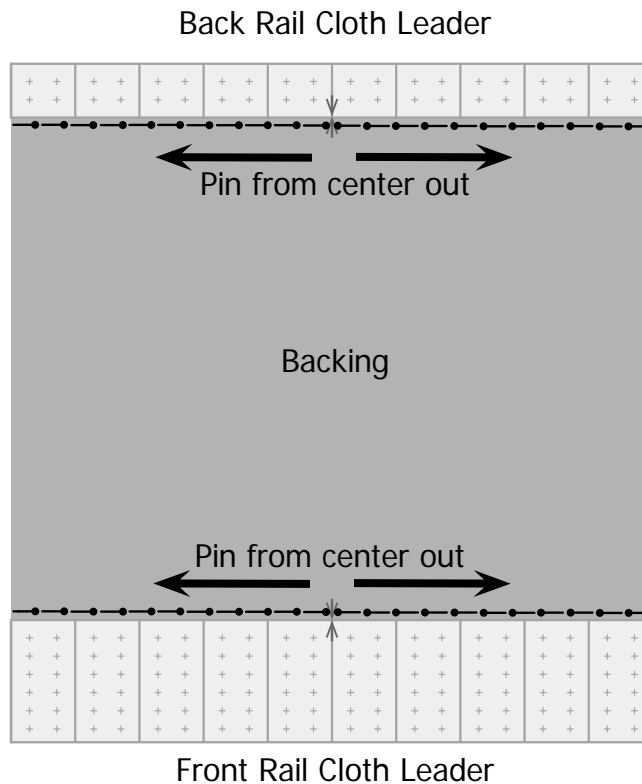

1-3 Match the center of each *Cloth Leader* with each center mark on the *Backing* and pin or baste from the center out to the end of the leader on both sides. Be sure there are no gaps between the pins.

With Cloth Leaders | Q-Zone Hoop Frame

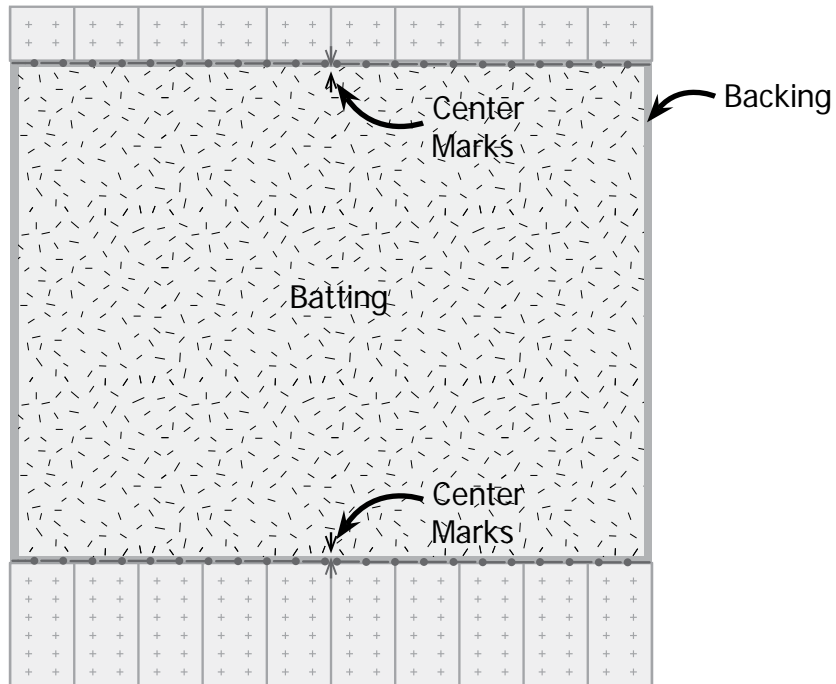

1-4 Find the center on your *Batting* on both the front and back rail edges and mark it. Lay your *Batting* centered on top of your *Backing* with the center marks aligned.

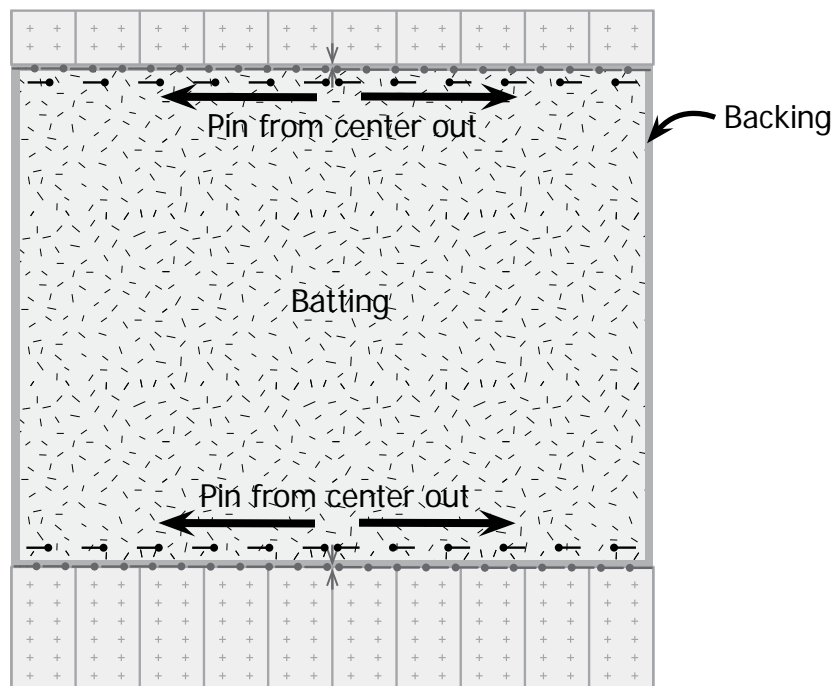

1-5 Pin the *Batting* to the *Backing* from the center out on the top and bottom edges of the *Batting*.

With Cloth Leaders | Q-Zone Hoop Frame

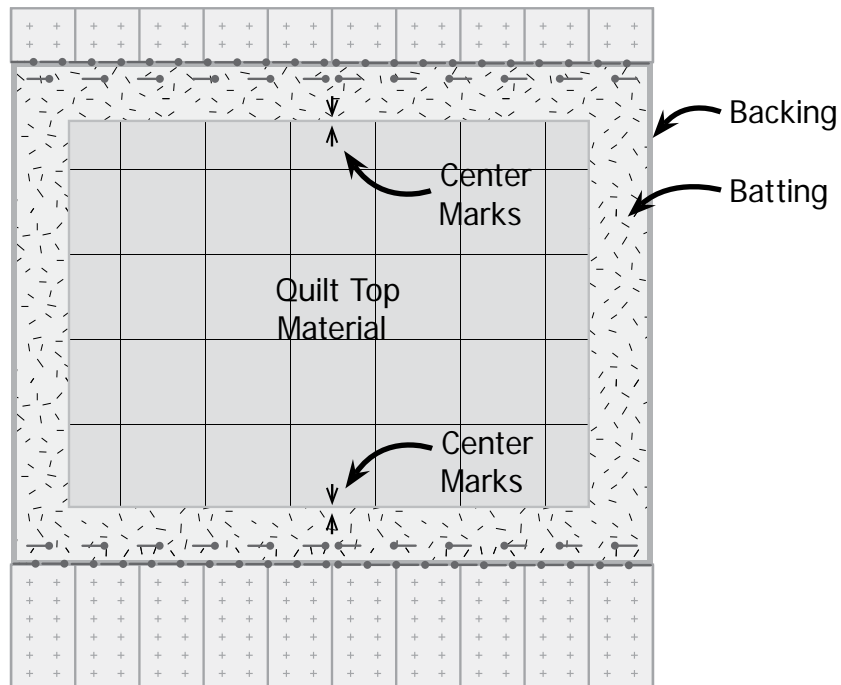

1-6 Find the center on your *Quilt Top Material* on both the front and back rail edges and mark it. Lay your *Quilt Top Material* centered on top of your *Batting* with the center marks aligned.

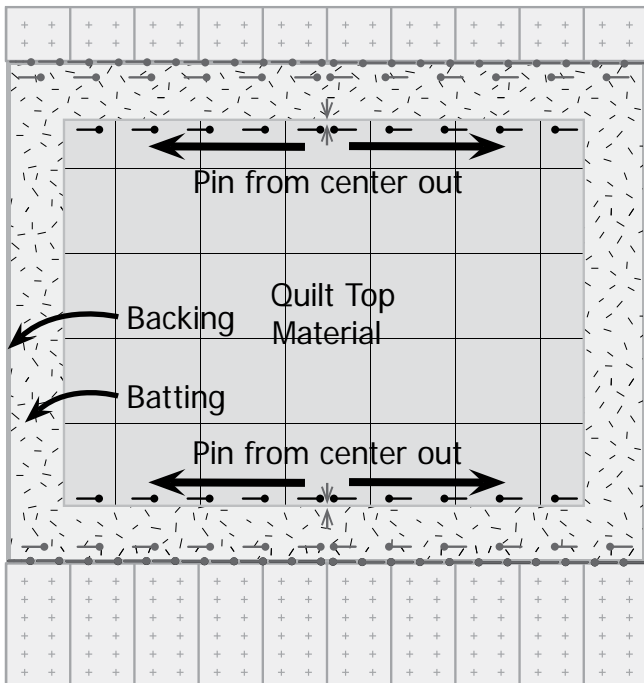

1-7 Pin the *Quilt Top Material* to the *Batting* and *Backing* from the center out along the top and bottom edges of the *Quilt Top Material*.

1-8 Roll the quilt toward the *Back Rail Cloth Leader*. Leave about 2 feet unrolled.

With Cloth Leaders | Q-Zone Hoop Frame

Step 2 – Fabric to Frame

Parts Needed:

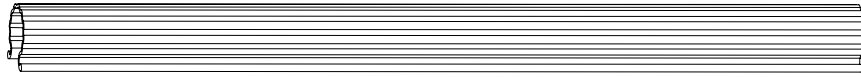

Front Fabric Clip (2)

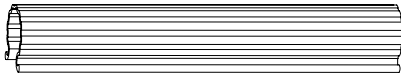

Side Fabric Clip (2)



Fabric Clip (3)

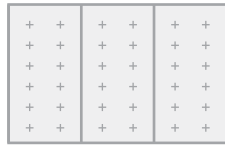

Side Rail Cloth Leader (2)

Tools Needed:

Pins or Masking Tape

Move sewing machine to back-left

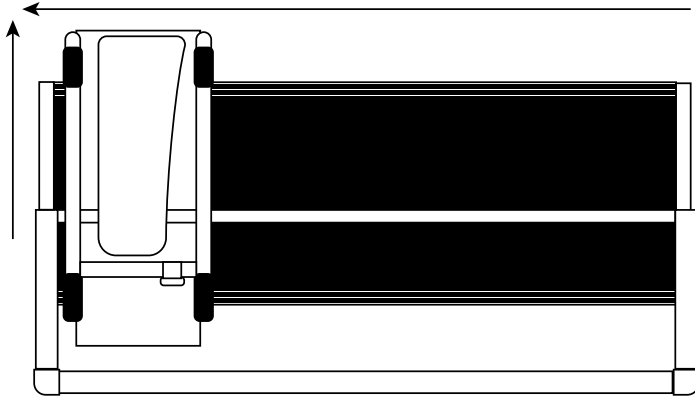

2-1 Roll your sewing machine to the far left and back side of the frame.

2-2 Lay your rolled fabric onto the rails of the quilting frame with the *Back Rail Cloth Leader* pulled toward the back long rail.

With Cloth Leaders | Q-Zone Hoop Frame



2-3 Pull the fabric through the throat of the machine and under the presser foot.

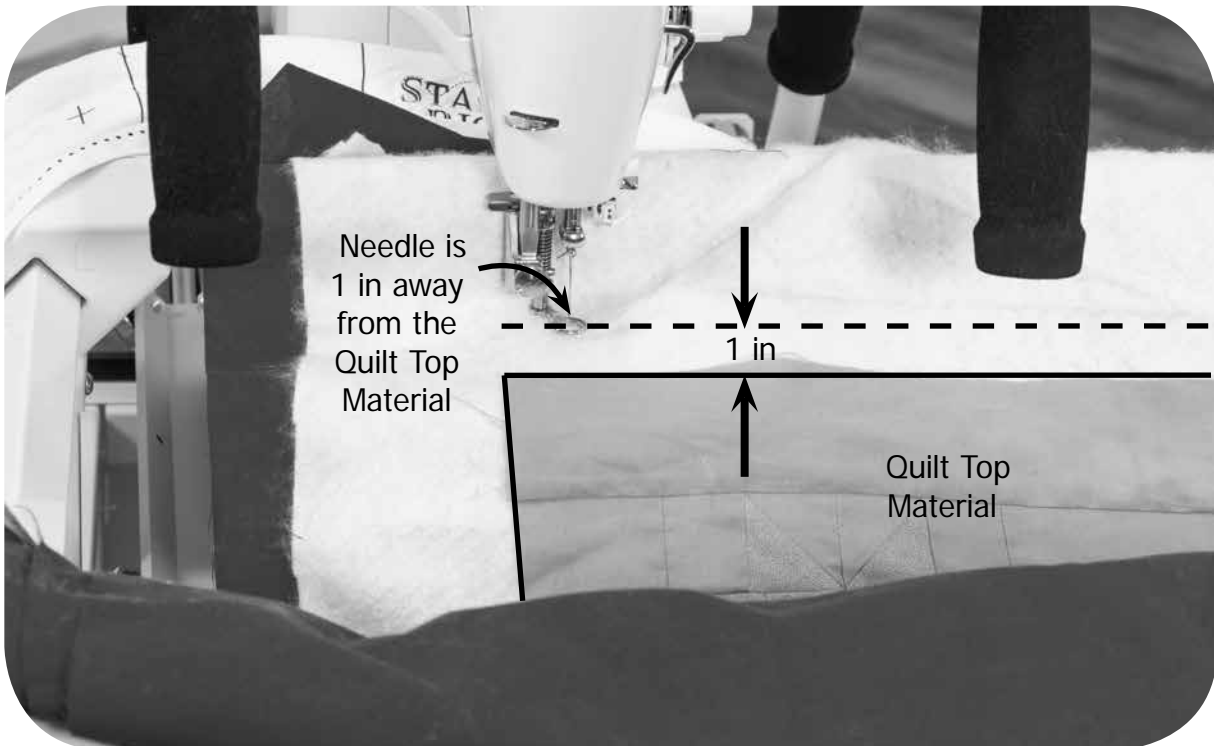

2-4 Roll the sewing machine to the back of the frame until it touches the back long rail. Then position the fabric so that the *Quilt Top Material* edge is approximately 1 inch away from the needle. While moving the sewing machine across the frame, adjust the *Quilt Top Material* so it is 1 inch away from the needle when the machine is touching the back long rail at any point while moving the machine across the frame.

With Cloth Leaders | Q-Zone Hoop Frame



2-5 Lay the Quilt over the back long rail of the quilting frame. Push one of the *Fabric Clips* over the top of the rail until it snaps into place. Check that your machine reaches the desired quilting area and if necessary remove the *Fabric Clip*, readjust your quilt placement and place the *Fabric Clip* on again.

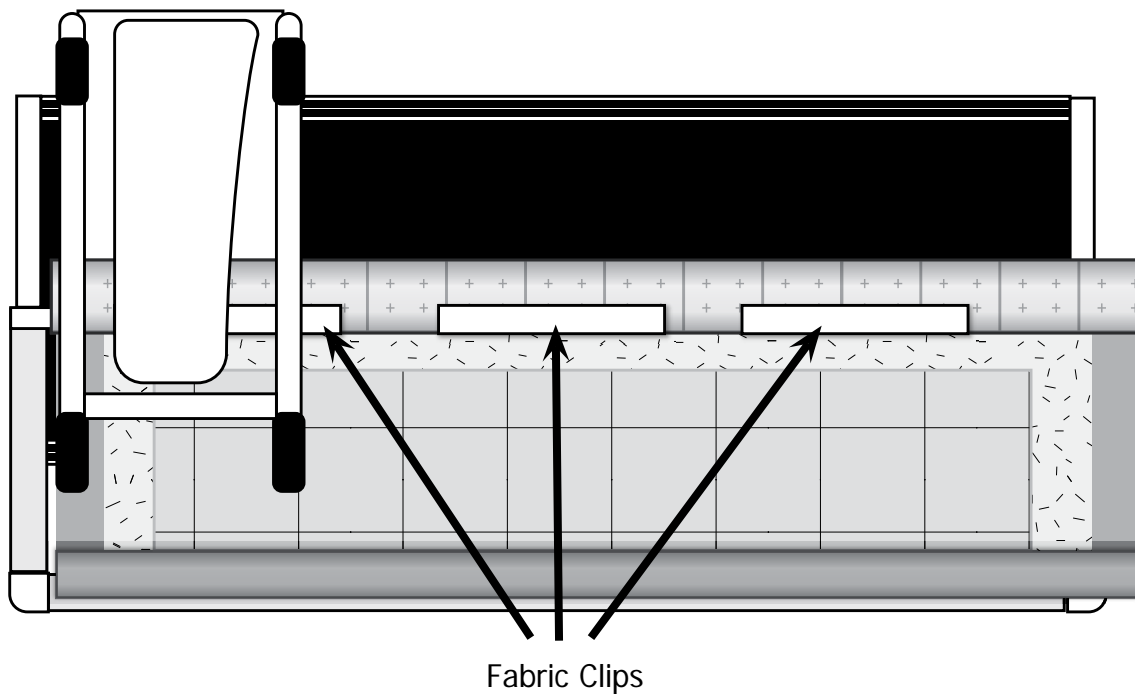

2-6 Repeat with the remaining (2) *Fabric Clips* while keeping the *Quilt Top Material* straight across the frame.

With Cloth Leaders | Q-Zone Hoop Frame



2-7 Unroll the *Quilt* towards you and down until it reaches the ground. Smooth it out to remove any wrinkles.



2-8 Use the straps on the back long rail to keep the extra quilt secured away from your sewing area. Roll the remaining *Back Rail Cloth Leader* and position it on top of the back long rail. Pull the straps over the roll of fabric and hook them onto the front edge of the *Fabric Clip*. Hold the *Fabric Clip* while you pull the end of the strap to tighten it in place. Repeat this for the other two *Fabric Clips*.

With Cloth Leaders | Q-Zone Hoop Frame



2-9 **Step A:** Push the top curved edge of the *Front Fabric Clip* onto the top corner of the rail.
Step B: Snap it into place over the *Quilt*.

2-10 Repeat with the other *Front Fabric Clip* on the other side.

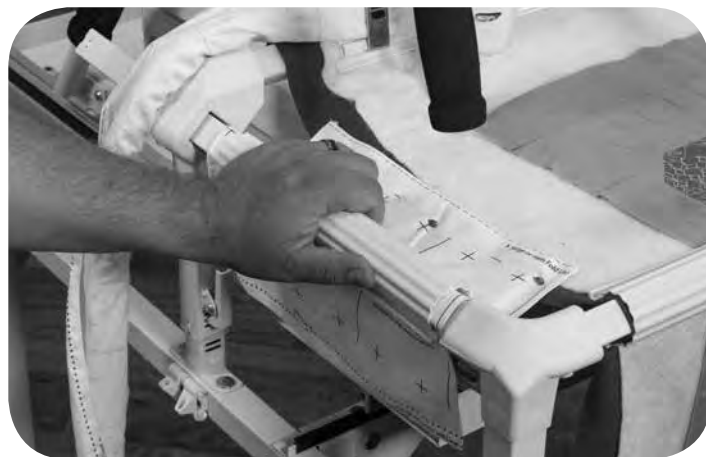

2-11 Attach the *Side Rail Cloth Leader* to the edge of the *backing* by pinning it. Drape the *Side Rail Cloth Leader* over the side of the frame and clip it to the side rail with the *Side Fabric Clip*. Install the *Side Fabric Clip* in the same manner as the *Front Fabric Clip*. Repeat with the other *Side Rail Cloth Leader* on the other side if the quilt does not reach the other side rail.

With Cloth Leaders | Q-Zone Hoop Frame

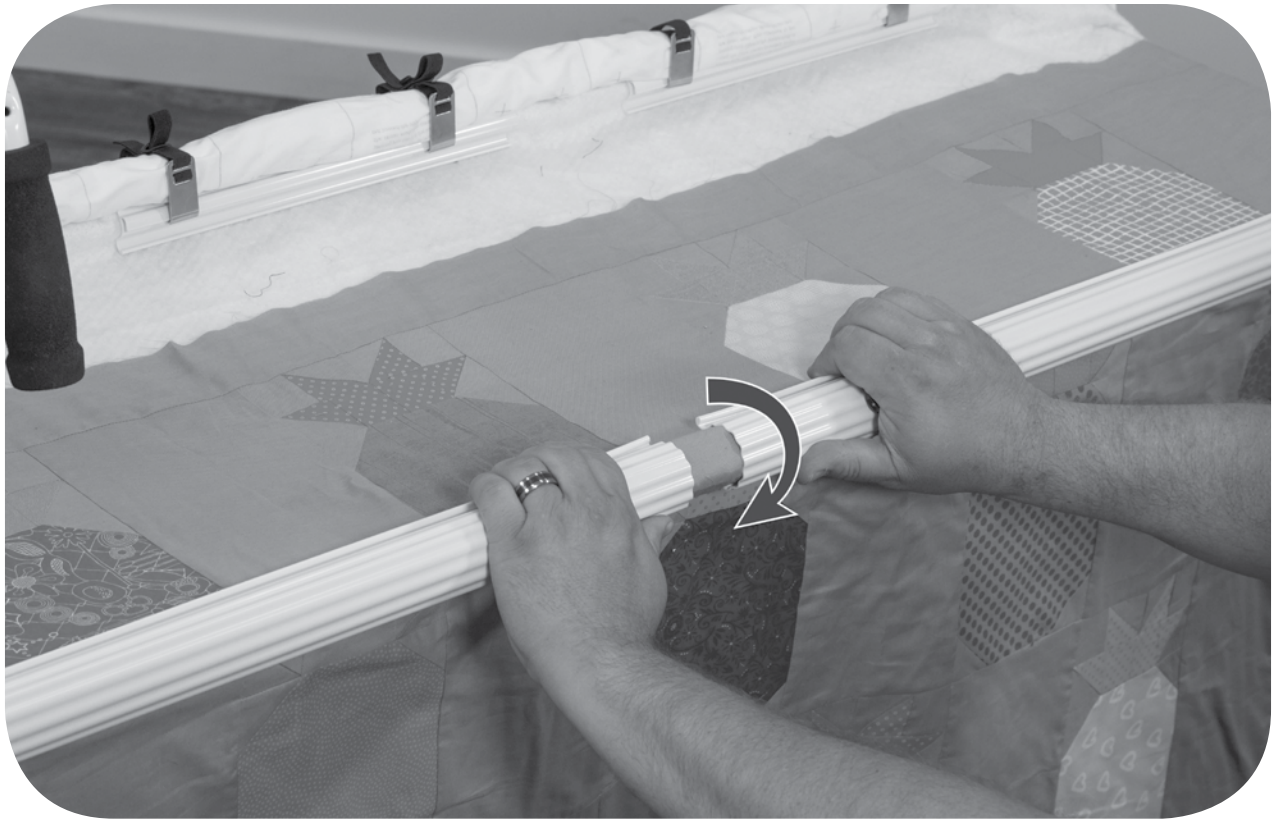

2-12 To add tension to the fabric, twist the *Front Fabric Clips* toward you a click or two (take care not to stretch the fabric).

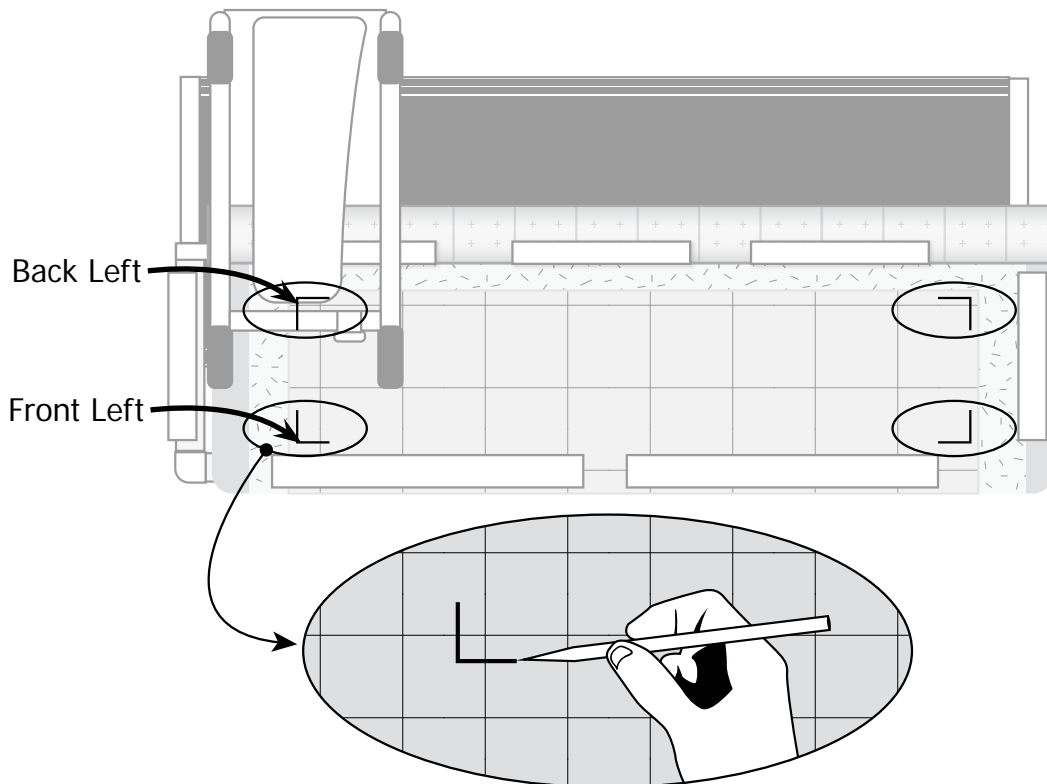

2-13 Mark your sewing area by moving your machine as far as possible to the back left and make a mark with chalk, tape, or a pin. Pull the machine forward toward the front rail as far as possible and mark again. Roll machine to the right of the frame and repeat the process.

You are now ready to begin sewing.

Step 3 – Moving Fabric to a New Quilting Zone

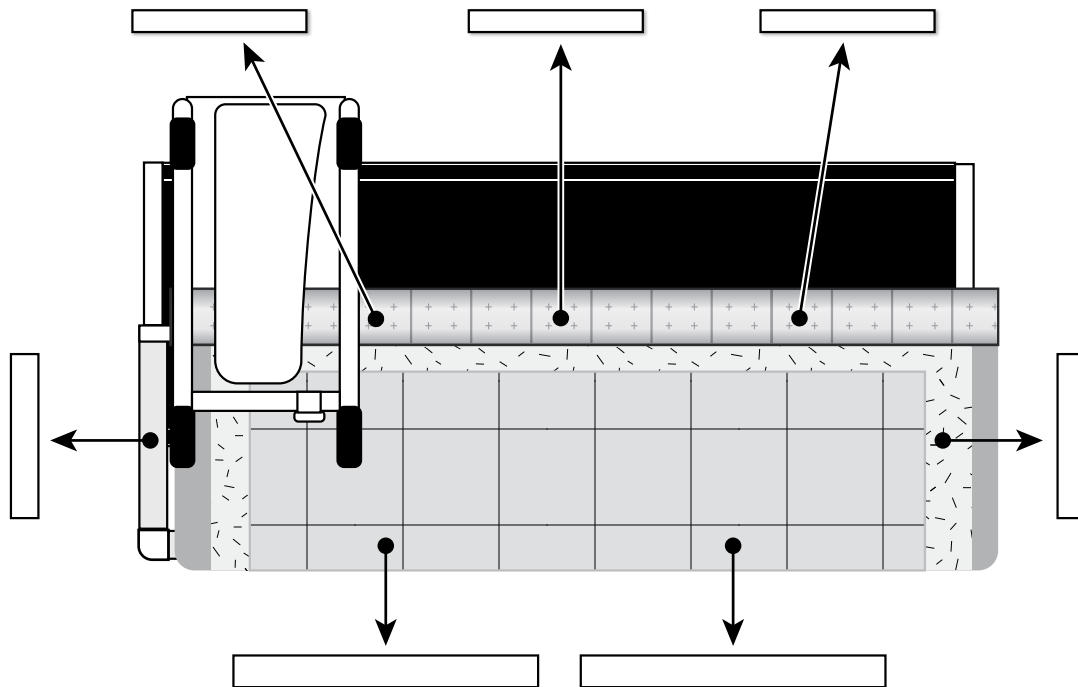

3-1 Remove all *fabric clips*. Make sure the sewing machine's needle is out of the fabric. Roll the sewing machine to the far left back side of the frame.

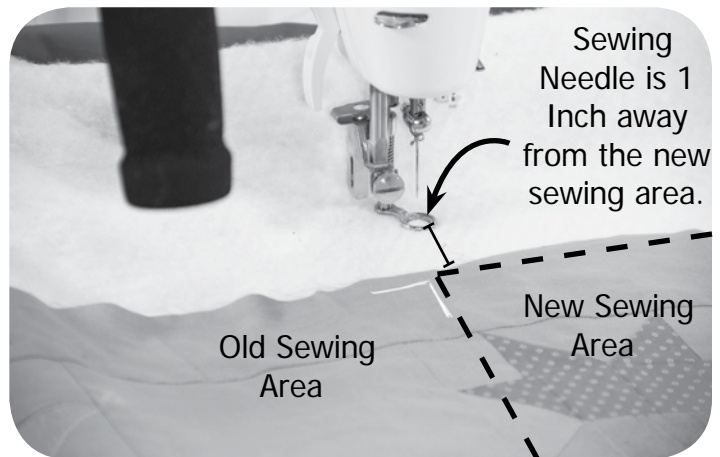

3-2 Slide the fabric across the frame to the new sewing area to your left. Confirm that your desired start point is within the new sewing area. Make sure the sewing machine is pushed all the way back and pull the fabric toward the back of the machine until the already sewn area is about 1 inch in front of the needle.

With Cloth Leaders | Q-Zone Hoop Frame

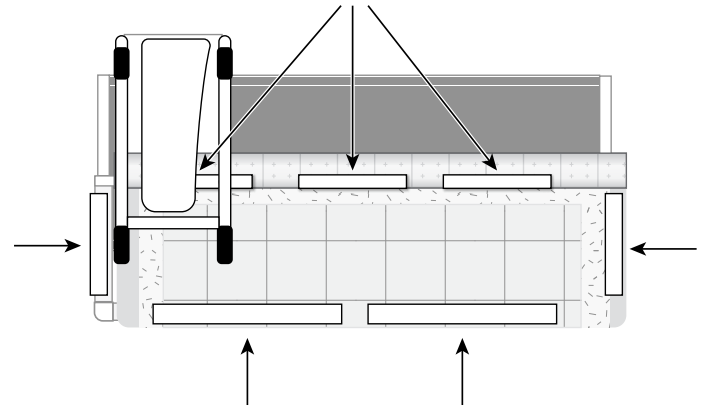

3-3 If the quilt does not reach the right side rail, pin the *Side Rail Cloth Leader* to the right side of the *Backing Material* and drape it over the side rail.

3-4 Clamp the fabric in place using the same method as before. Be sure not to stretch the fabric.

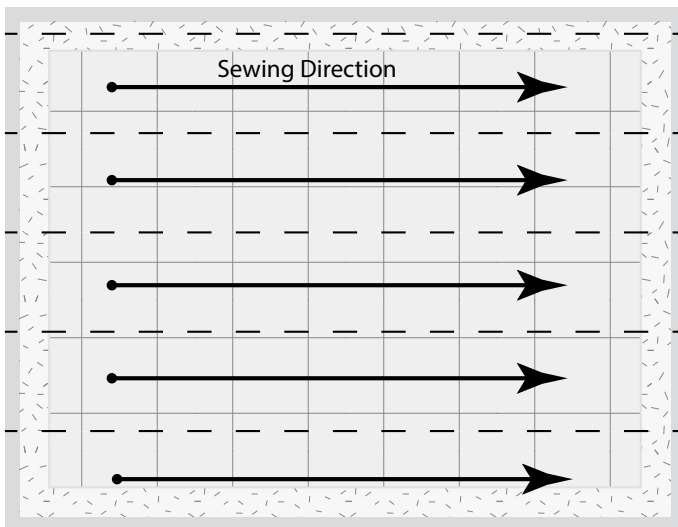

3-5 After having finished your 1st row, pull the fabric to the right so that you can start your next row sewing from left to right. Continue in this pattern until your quilt is complete.

Installing Fabric Without Using Cloth Leaders

Creating a quilt without using Cloth Leaders requires using a larger backing for your quilt. The following are instructions on how to set up your project without using Cloth Leaders.

Without Cloth Leaders | Q-Zone Hoop Frame

Step 1 – Quilt Preparation

Materials Needed:



Backing Material

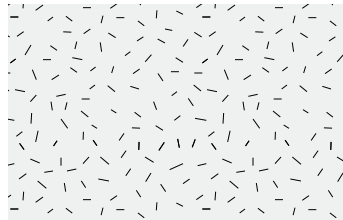

Batting Material

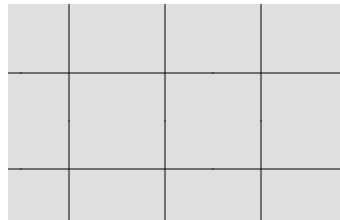

Quilt Top Material

Tools Needed:

Pins or Masking Tape

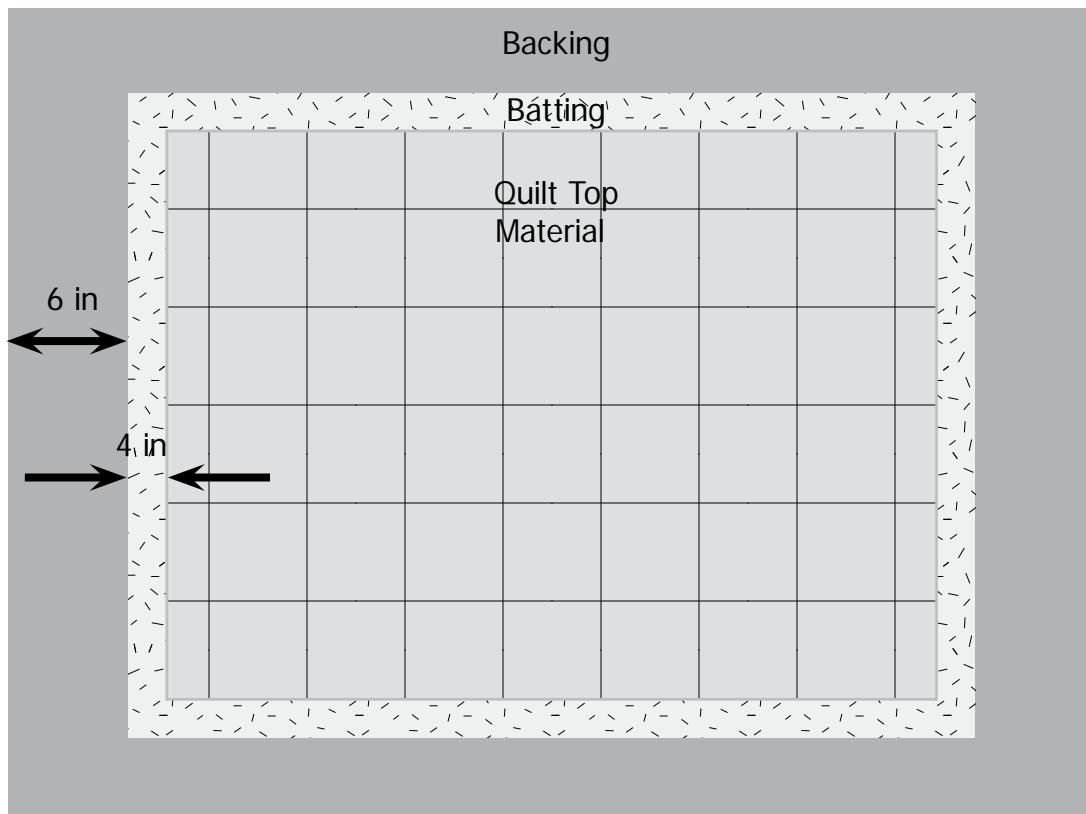

1-1 Cut your *Backing* **12 in** longer and wider (**6 in** in all directions) than your *Quilt Top Material*. Cut your *Batting* **8 in** longer and wider (**4 in** in all directions) than your *Quilt Top Material*.

Without Cloth Leaders | Q-Zone Hoop Frame

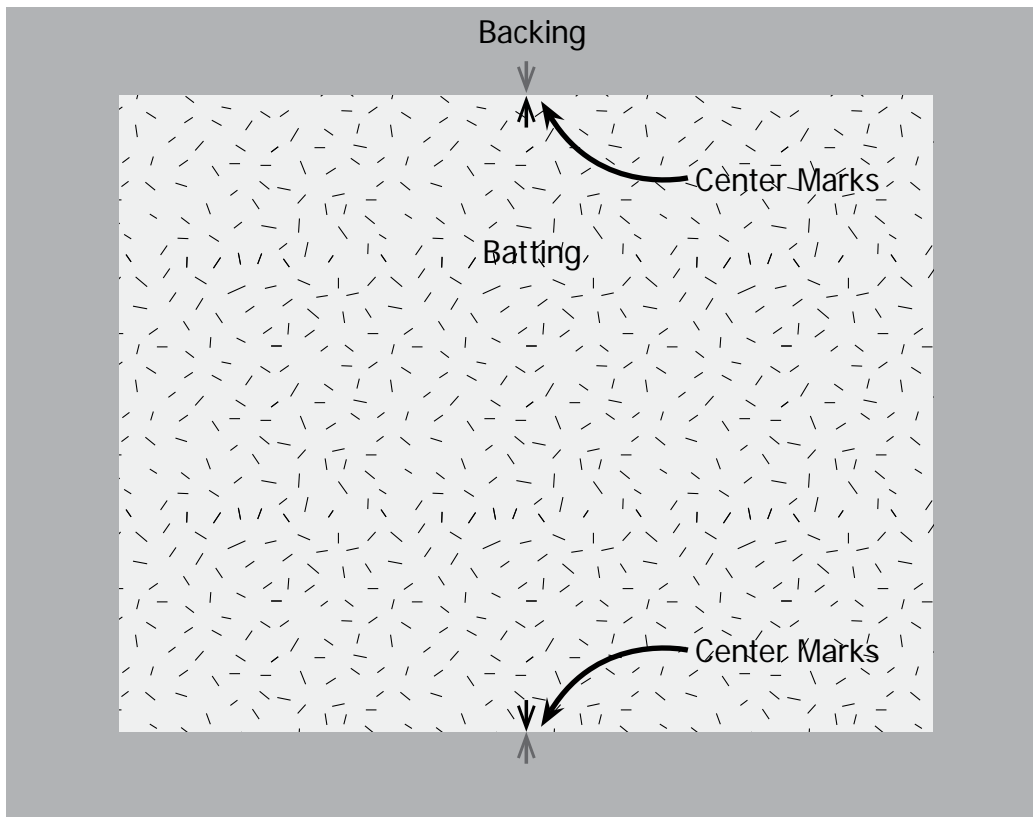

1-2 Find the center on your *Batting* on both the front and back rail edges and mark it. Lay your *Batting* centered on top of your *Backing* with the visible side down and with the center marks aligned.

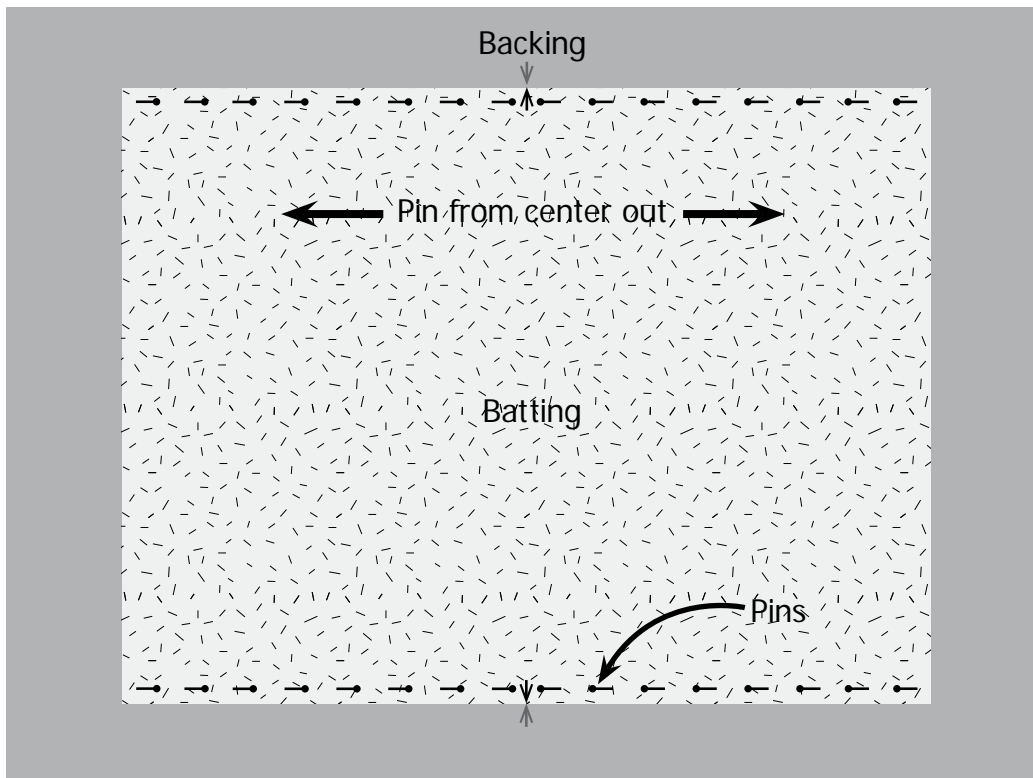

1-3 Pin the *Batting* to the *Backing* from the center out on both the top and bottom edges of the *Batting*.

Without Cloth Leaders | Q-Zone Hoop Frame

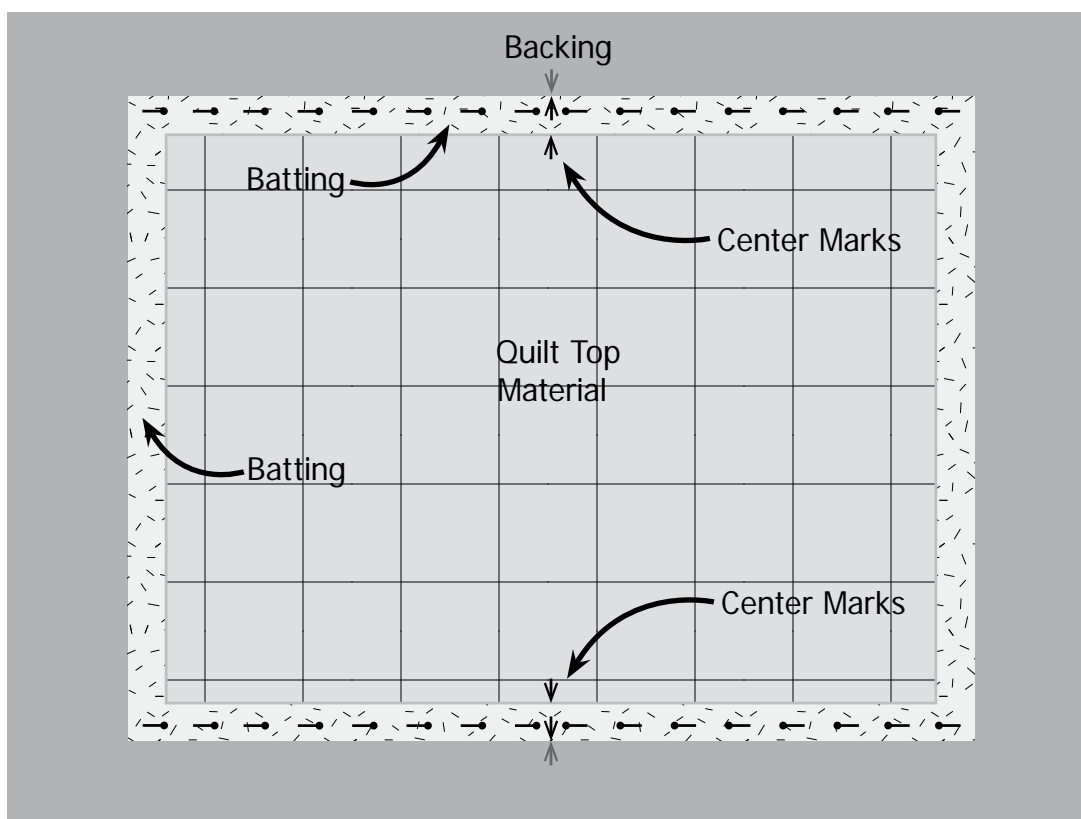

1-4 Find the center on your *Quilt Top Material* on both the front and back rail edges and mark it. Lay your *Quilt Top Material* with the visible side up centered on top of your *Batting* with the center marks aligned.

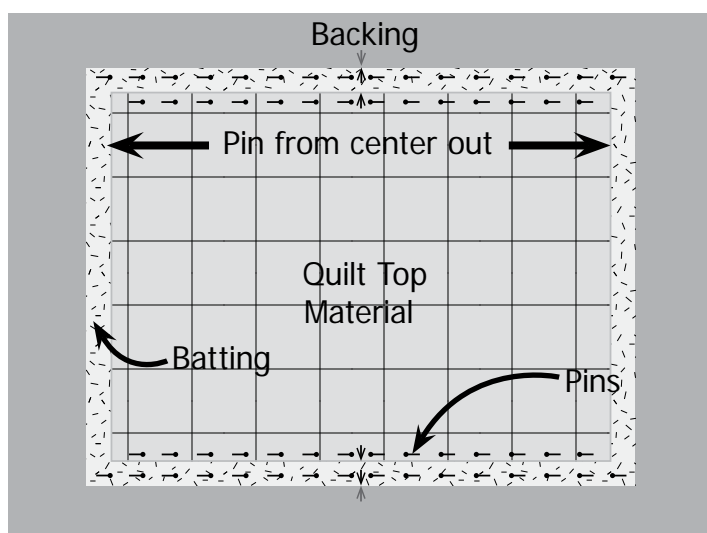

1-5 Pin the *Quilt Top Material* to the *Batting* and *Backing* from the center out on both the top and bottom edges of the *Quilt Top Material*.

1-6 Roll the quilt up toward the back of the quilt. Leave about 2 feet unrolled.

Without Cloth Leaders | Q-Zone Hoop Frame

Step 2 – Fabric to Frame

Parts Needed:

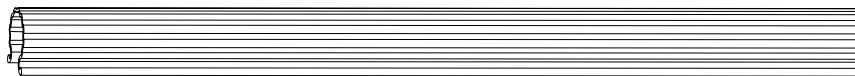

Front Fabric Clip (2)

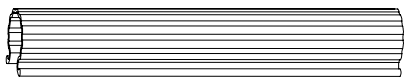

Side Fabric Clip (2)



Fabric Clip (3)

Tools Needed:

Pins or Masking Tape

Move sewing machine to back-left

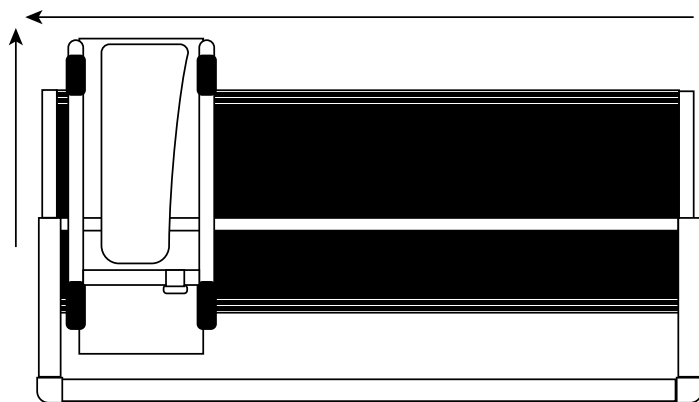

2-1 Roll your sewing machine to the far left and back side of the frame.

2-2 Lay your rolled fabric onto the hoop area of the quilting frame with the top of the quilt draped over the back long rail.

Without Cloth Leaders | Q-Zone Hoop Frame



2-3 Pull the fabric through the throat of the machine and under the presser foot.

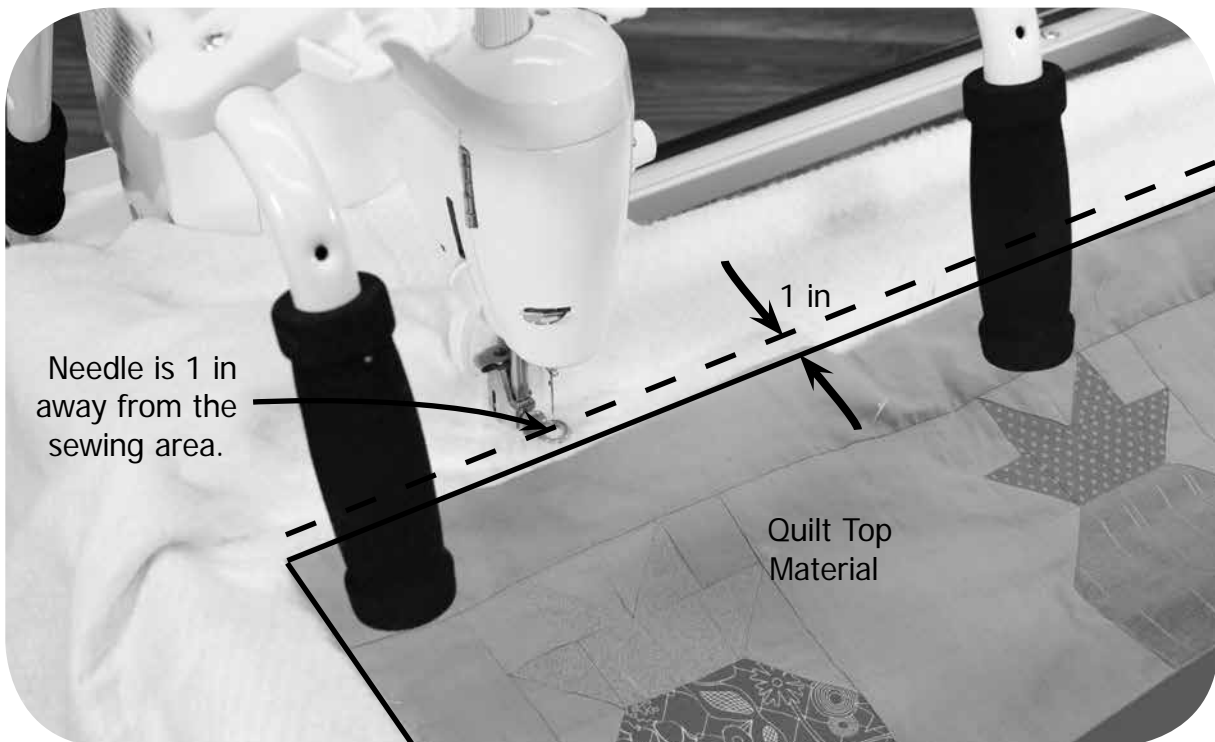

2-4 Roll the sewing machine to the back of the frame until it touches the back long rail. Then position the fabric so that the *Quilt Top Material* edge is approximately 1 inch away from the needle. While moving the sewing machine across the frame, adjust the *Quilt Top Material* so it is 1 inch away from the needle when the machine is touching the back long rail at any point while moving the machine across the frame.

Without Cloth Leaders | Q-Zone Hoop Frame



2-5 Lay the Quilt over the back long rail of the quilting frame. Push one of the *Fabric Clips* over the top of the rail until it snaps into place. Check that your machine reaches the desired quilting area and if necessary remove the *Fabric Clip*, readjust your quilt placement and place the *Fabric Clip* on again.

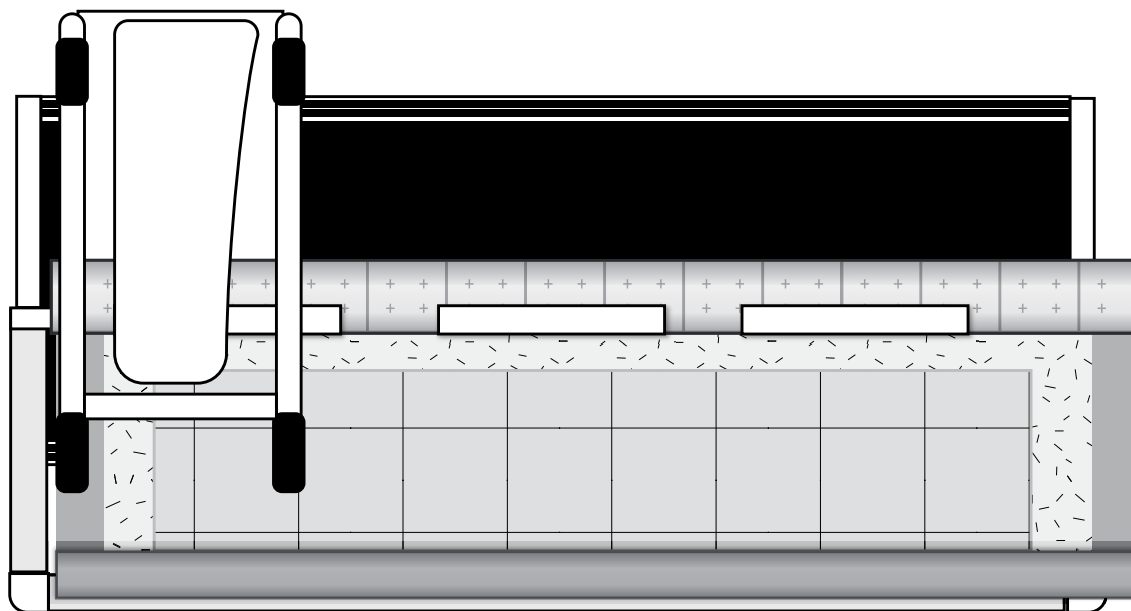

2-6 Repeat with the remaining (2) *Fabric Clips* while keeping the *Quilt Top Material* straight across the frame.

Without Cloth Leaders | Q-Zone Hoop Frame



2-7 Unroll the *Quilt* towards you and down until it reaches the ground. Smooth it out to remove any wrinkles.



2-8 Use the straps on the back long rail to keep the extra quilt secured away from your sewing area. Roll the remaining *Back Rail Cloth Leader* and position it on top of the back long rail. Pull the straps over the roll of fabric and hook them onto the front edge of the *Fabric Clip*. Hold the *Fabric Clip* while you pull the end of the strap to tighten it in place. Repeat this for the other (2) *Fabric Clips*.

Without Cloth Leaders | Q-Zone Hoop Frame



2-9 **Step A:** Push the top curved edge of the *Front Fabric Clip* onto the top Corner of the rail.
Step B: Snap it into place over the *Quilt*.

2-10 Repeat with the other *Front Fabric Clip*.



2-11 Clamp the quilt to the side rails with the *Side Fabric Clips* in the same manner as before.

Without Cloth Leaders | Q-Zone Hoop Frame

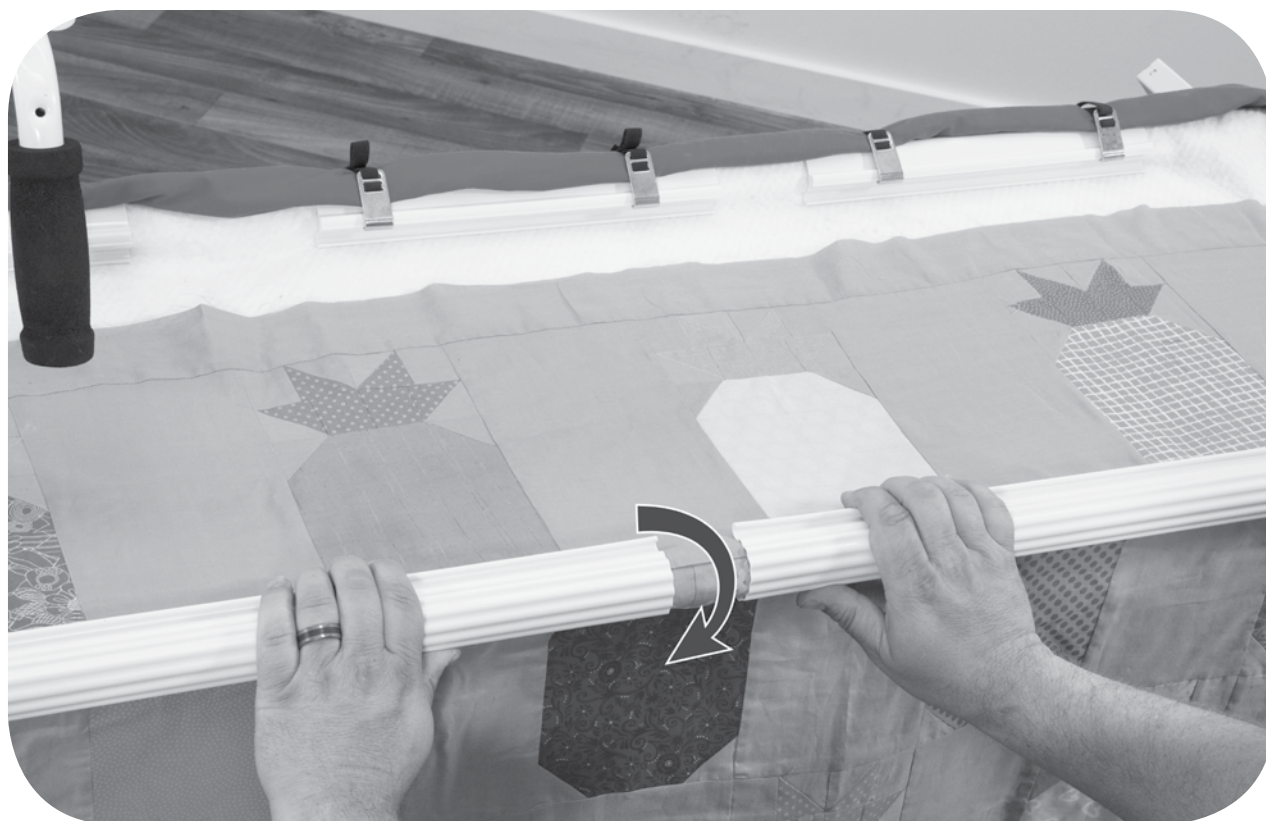

2-12 To add tension to the fabric, twist the *Front Fabric Clips* toward you a click or two (take care not to stretch the fabric).

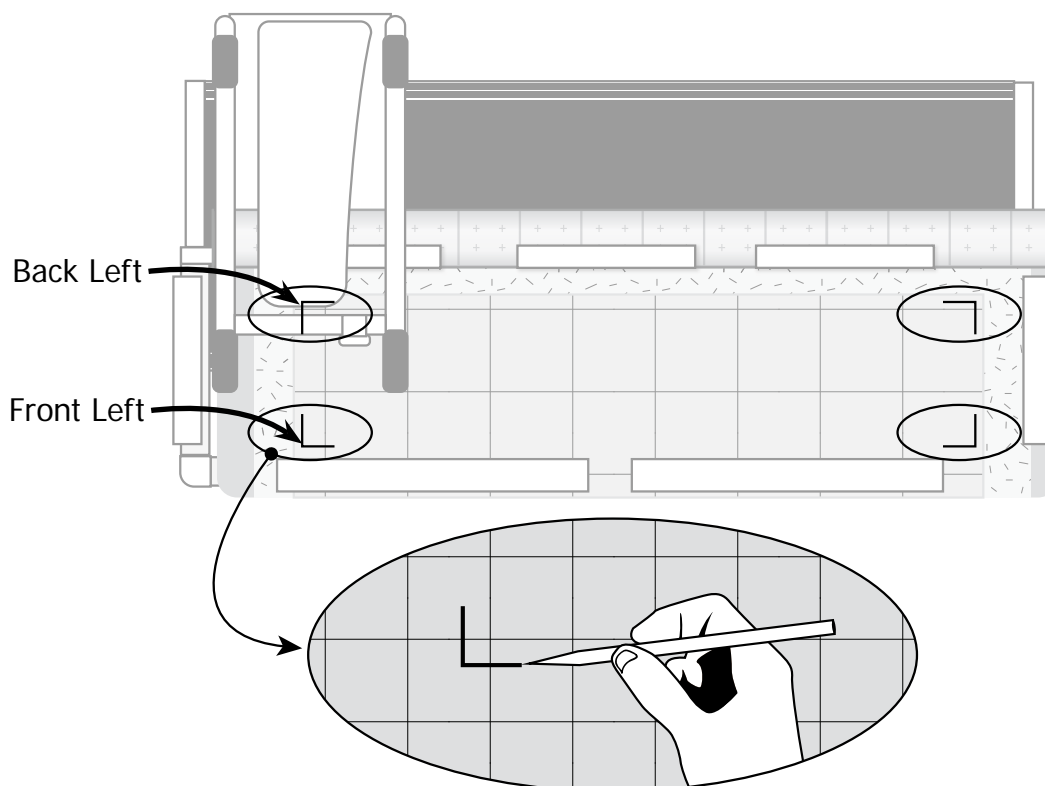

2-13 Mark your sewing area by moving your machine as far as possible to the back left and make a mark with chalk, tape, or a pin. Pull the machine forward toward the front rail as far as possible and mark again. Roll machine to the right of the frame and repeat the process.

You are now ready to begin sewing.

Without Cloth Leaders | Q-Zone Hoop Frame

Step 3 – Moving Fabric to a New Quilting Zone

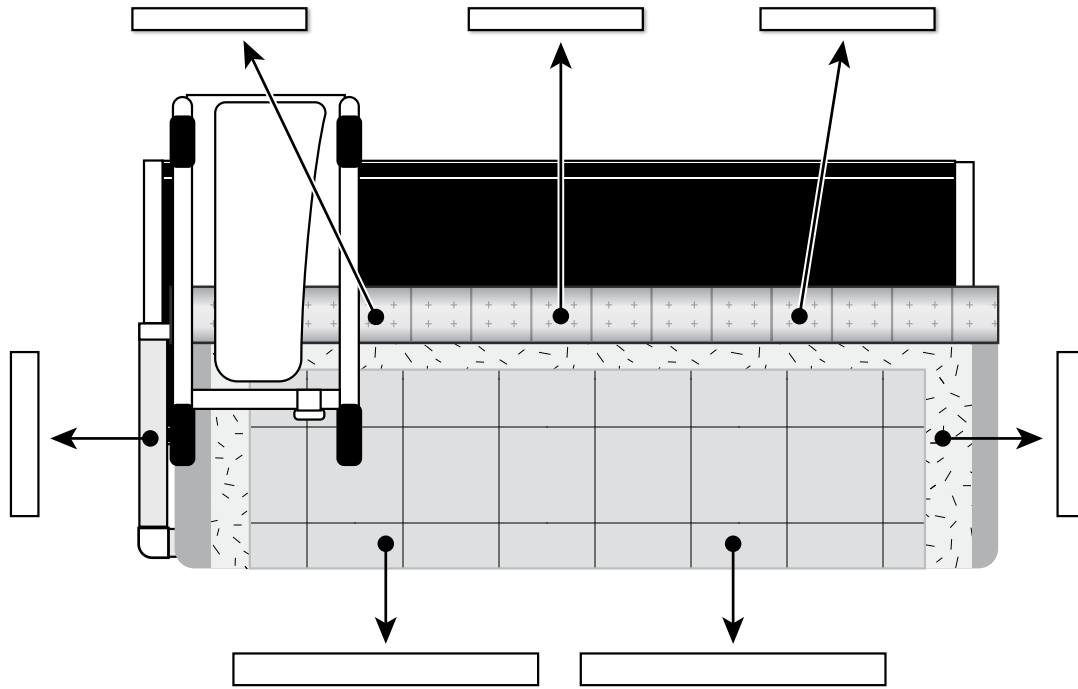

3-1 Remove all *fabric clips*. Make sure the sewing machine's needle is out of the fabric. Roll the sewing machine to the far left back side of the frame.

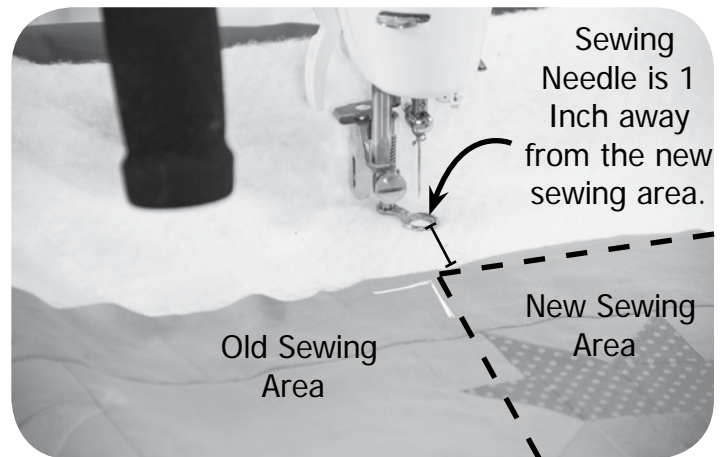

3-2 Slide the fabric across the frame to the new sewing area to your left. Confirm that your desired start point is within the new sewing area. Make sure the sewing machine is pushed all the way back and pull the fabric toward the back of the machine until the already sewn area is about 1 inch in front of the needle.

Without Cloth Leaders | Q-Zone Hoop Frame

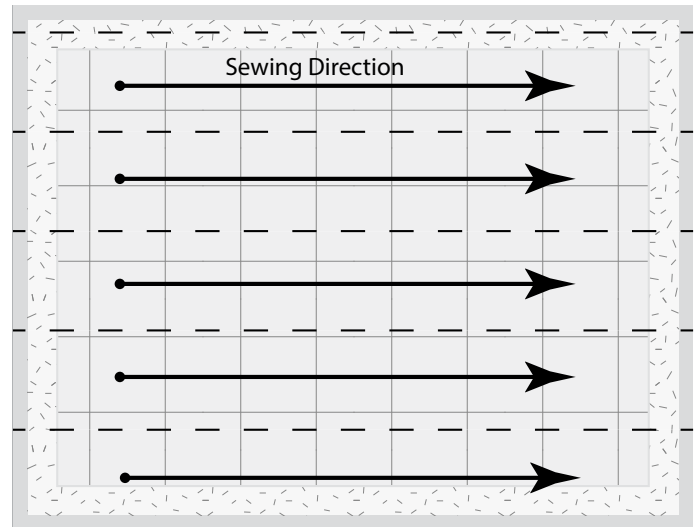
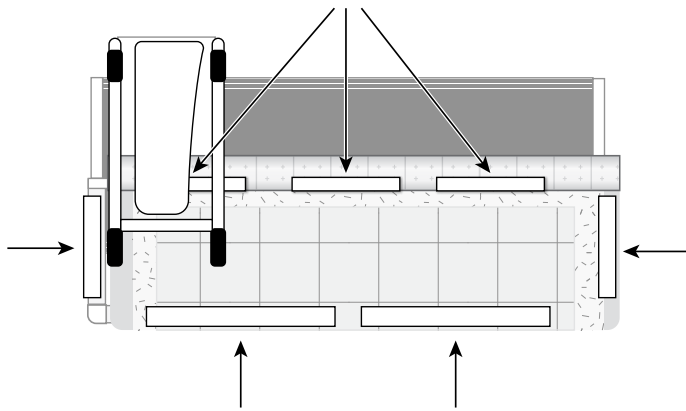

3-3 Clamp the fabric in place using the same method as before. Be sure not to stretch the fabric.

3-4 After having finished your 1st row, pull the fabric to the right so that you can start your next row sewing from left to right. Continue in this pattern until your quilt is complete.

Using Bungee Clamps for Smaller Projects

The included Bungee Clamps will allow you to use your frame for smaller projects.

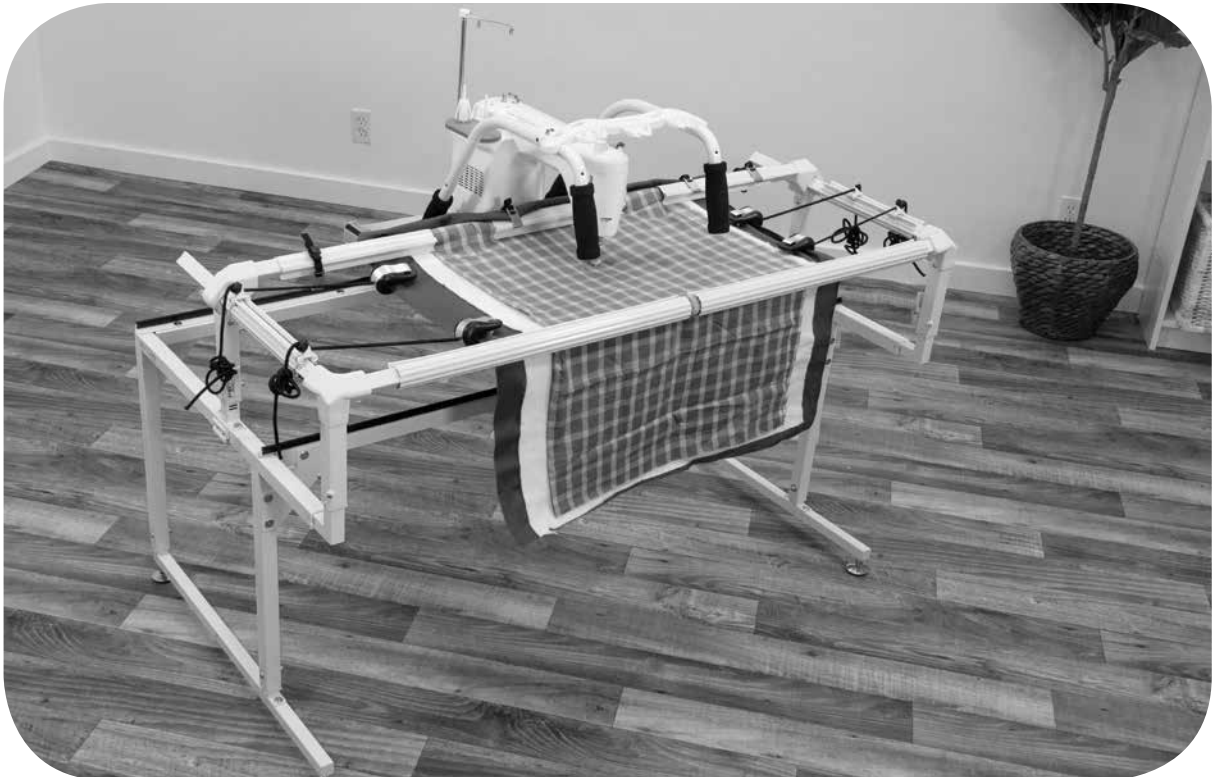

Bungee Clamps | Q-Zone Hoop Frame

Step 1 – Bungee Clamp Setup for Smaller Projects

Parts Needed:

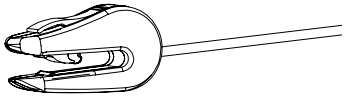

Bungee Clamp Assembly (4)

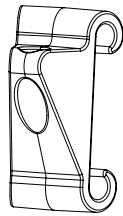

Bungee Mount (2)



Side Fabric Clip (2)



Front Fabric Clip (2)



Bungee Stop (4)

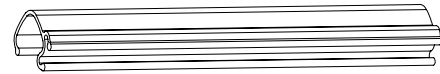

Fabric Clip (3)



1-1 Press the *Side Fabric Clip* onto the bottom of the side rail.



1-2 Slide the *Bungee Mounts* onto the *Side Fabric Clip* from the side.

Bungee Clamps | Q-Zone Hoop Frame

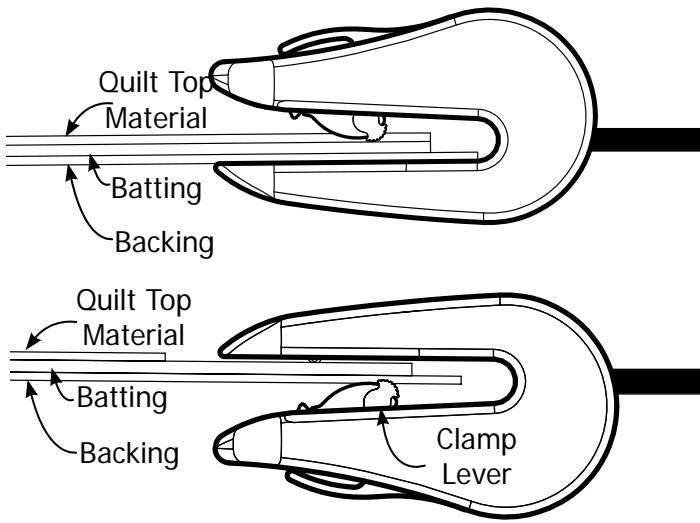

1-3 Slip the *Quilt Top Material*, *Batting* and *Backing* into the mouth of each *Bungee Clamp*. If the clamp lever is on the *Batting*, flip the clamp over so that the lever is gripping the *Backing* instead of the *Batting*.

1-4 Slide the bungee cords through the holes on the *Bungee Mounts* and attach the *Bungee Stop* to the end of each cord.

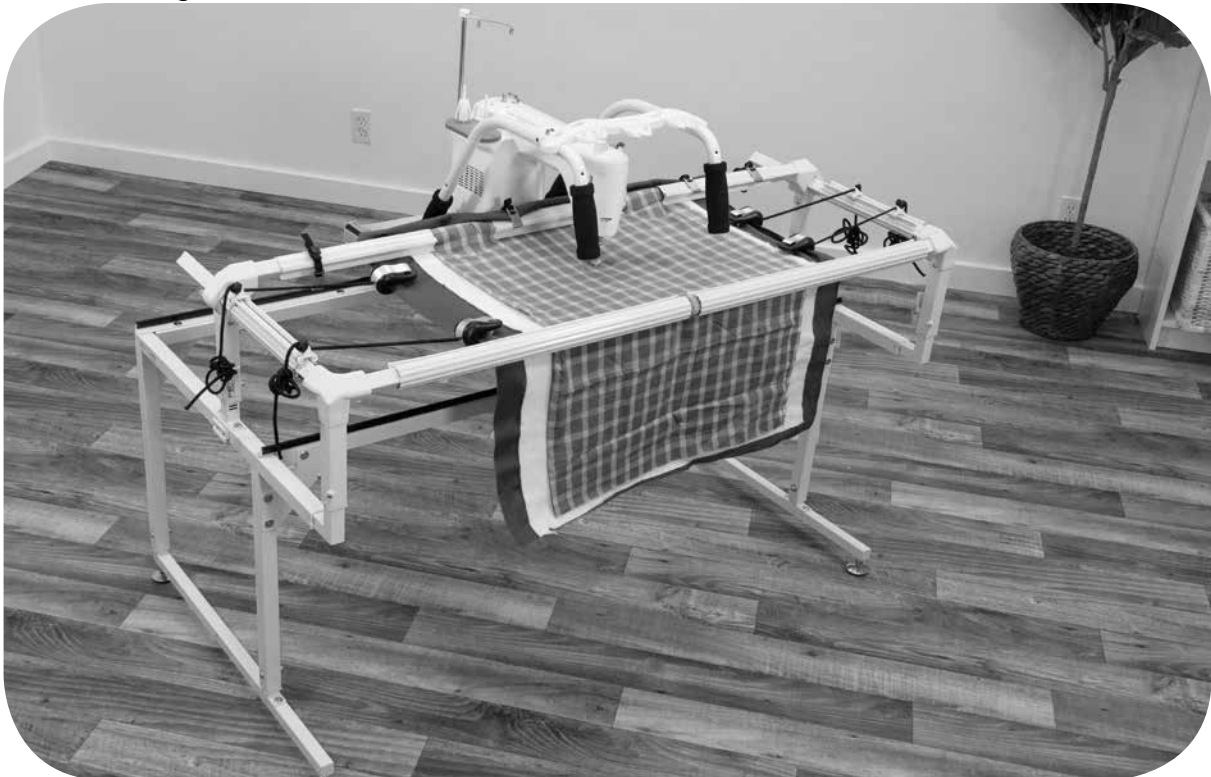

1-5 Center your project on the frame, secure it onto the back and front rails with the *Front Fabric Clips* and *Fabric Clips* and enjoy quilting.